

Clip CH50 Series

Thermal Imaging Attachment

User Manual

IRay Technology Co., Ltd.

Contents

1. Description.....	4
2. Components and Controls.....	5
2.1 Components	5
2.2 Controls.....	6
3. Menu/Status Bar Icons.....	7
4. Specifications.....	8
5. System Function	9
6. Operation System.....	10
6.1 Power on / Power off	10
6.2 Standby Mode	10
6.3 Status bar.....	10
6.4 Navigation Menu	10
6.5 Advanced Menu	11
6.6 Image Calibration.....	13
6.7 E-Zoom center adjustment.....	14
6.8 Bad Pixel Calibration.....	15
6.9 Compass Calibration.....	15
6.10 Stadiametric Rangefinder (Only for Monocular).....	16
7. Accessory Equipment: Remote control/ Mobile App	18
7.1 Bluetooth Remote Controller	18
7.2 Mobile App	19
8. Preventative Maintenance.....	20
8.1 Battery Installation.....	20
8.2 Product Cleaning and Maintenance	20
8.3 Safety Regulation.....	21
9. General Trouble Shooting.....	22
10. Appendix.....	23
10.1 User Interface Description	23

10.2 Product Dimensions	23
10.2.1 Boundary Dimension	23
10.2.2 Bottom Mounting Hole Size	24

1. Description

Clip CH50 Series is a multifunctional thermal imager device equipped with two kinds of eyepiece that can be used either as a monocular or a front attachment as the infrared expansion device of day light. Different from the night vision device based on image enhancement, Clip CH50 Series doesn't need external light source and isn't influenced by strong light exposure. It can be used in the night or bad weather conditions such as fog, rain, smog and can detect the objects through obstacles such as branch, tall grass, dense bushes and so on. Clip CH50 Series has a wide range application including night hunting, observation and terrain orientation, search and rescue operations.



Fig. 1-1 Clip CH50 Series thermal imaging attachment

2. Components and Controls



Fig. 2-1 Function introduction

2.1 Components

No.	Name	Function description
①	Lens Cap	Protecting the lens and using for background correction
②	Objective Lens	——
③	Lens Focus knob	Used to adjust the focal length of objective lens to make the image to be the clearest when the image is indistinct.
④	Power(P) Button	Power on/Power off/Standby/Up/Left
⑤	Menu(M) Button	Entering menu/Parameter switch
⑥	Correction(C) Button	Shutter correction/Background correction /Down/Right
⑦	Locking Ring of Attachment's Eyepiece	Locking the Attachment's eyepiece to Clip C unit.
⑧	Bayonet-type ring of attachment's eyepiece	Used to lock the adapter ring between the day light sight and the attachment
⑨	Attachment's Eyepiece	Eyepiece as the infrared expansion attachment of day light sight
⑩	Battery Compartment Cover	Using two batteries which are CR123, CR123A or 16340 to supply power.

⑪	Type-C Interface	Used for data communication and external power supply
---	------------------	---

2.2 Controls

Operation in normal display mode			Operation in menu mode/calibration interface		
	Short Press	Long Press		Short Press	Long Press
P (4) Button	Standby/ Awaken	Power on / Power off	P (4) Button	Adjust parameter /Scroll up options	——
M (5) Button	Enter the Menu Navigation	Enter the advanced menu	M (5) Button	Function switch/Parameter selection	Save and exit menu
C (6) Button	Shutter Calibration	Background Calibration	C (6) Button	Adjust parameter/Scroll down options	——
M (5) Button + P (4) Button	——	Monocular: Enter stadia metric rangefinder interface	P (4) Button	Increase the distance between measurement bars	Quickly zoom in
			M (5) Button	——	Exit
			C (6) Button	Reduce the distance between measurement bars	Quickly zoom out
P (4) Button + C (6) Button	——	Enter the compass calibration interface			

3. Menu/Status Bar Icons

	Screen lightness setup--four levels
	Image mode: B (Black hot), W (White hot), R (Red hot), C (Pseudo Color)
	Image Sharpness: levels 1-4
	E-zoom (Only for Monocular: $\times 1$, $\times 2$, $\times 4$)
	Ultraclear mode
	Bluetooth option
	Bluetooth connected
	Video output option
	Video output on
	Battery type selection
	Reticle type, four customize sorts
	Image calibration
	E-Zoom center adjustment
	Bad pixel correction option
	Factory reset
	Battery capacity indicator
	Type-C power supply
	Orientation shift

4. Specifications

Model	Clip CH50
Detector Parameters	
Detector Type	VOx Uncooled
Resolution	640*512
Pixel Size	12um
NETD	≤40mk
Frame Rate	50Hz
Optics Parameters	
Objective Lens	50mm
Field of View	8.8 °×7.0 °
Magnification	Attachment: 1 ×
Diopeter Adjustment	-5D ~ +5D
Detection Range (Target size: 1.7m ×0.5m, P(n)=99%)	2597
Display Parameters	
Type	OLED
Resolution	1024×768
Electrical Parameters	
Battery	CR123 ×2
Power Consumption	<1200mW
Max. Battery Life	4hr
External Interface	
USB Interface	Type-C
Video Output	PAL (RCA Port)
External Power	Type-C
Functions	
Digital Compass	√

Motion Sensor	√
Remote Control	Bluetooth
Physic Parameters	
IP Rating	IP66
Weight (without batteries)	<510g
Dimension	167mm×74mm×68mm
Adapter Ring	M52×0.75

5. System Function

- Detection range beyond 2.5km
- 1024×768 high resolution OLED display
- Bluetooth remote control
- Four image modes – white hot, black hot, red hot, pseudo color
- Monocular digital zoom: ×1, ×2, ×4
- Type-C interface power supply and data transmission
- PAL analog video output
- Build-in compass, motion sensor
- IP66 protection level
- Compact size
- Light weight and great impact resistance

6. Operation System

6.1 Power on / Power off

Press and hold down **P (4)** button for 3s to start up the device, the image appears on the display screen. After 6s, the device is turned on.

Press and hold down **P (4)** button for about five seconds to shut down the device.

6.2 Standby Mode

Enter/exit the standby mode with pressing the **P (4)** button briefly for power saving.

6.3 Status bar

The status bar is located at the bottom of the screen, which shows information such as image mode, screen brightness, E-Zoom, Reticule types, Sharpness, Bluetooth (on), ultra-clear mode (on), video out (on), battery status.

6.4 Navigation Menu

In the normal display interface, press **M (5)** button briefly to switch in the order of "none menu - screen brightness - image mode - sharpness - E-zoom - exit the navigation menu". And press **P (4)** button and the **C (6)** key to adjust the parameters of each function. Navigation menu interface is as shown in fig. 6-1.



Fig. 6-1 Navigation Menu

- **Screen brightness:** 1~4 brightness level.
- **Image mode:** W (White hot), B (Black hot), R (Red hot), C (pseudo color).

- **Image sharpness:** 1-4 levels of sharpness.
- **E-zoom (only for monocular):** $\times 1/\times 2/\times 3/\times 4$.

6.5 Advanced Menu

Press and hold down the **M (5)** button for three seconds to enter the advanced menu interface (fig. 6-2). The six functional options from top to bottom are Ultraclear mode, Bluetooth, video out, reticle type, battery type, Image calibration, E-Zoom center adjust,

bad pixel correction, and factory reset. Please referring to table 6-1 for details.









Fig. 6-2 Advanced menu interface

Operations:

- In the advanced menu, press **M (5)** button briefly to adjust the parameters of present option or enter the secondary menu.
- **P (4)** button is used to shift up or left. **C (6)** button is used to shift down or right;
- Press and hold down **M (5)** button for three seconds to exit advanced menu interface.

Table 6-1 Advanced menu function description

Icon	Name	Function	Description	Status
	Ultraclear Mode	Conversion of normal mode and Ultraclear mode	In this mode, the image contrast is enhanced, which is suitable for cloudy, rainy, foggy and other harsh weather conditions	The icon displays at the status bar.

	Bluetooth	ON/OFF	When Bluetooth is on, it can be operated with the Bluetooth remote controller or mobile phone APP (please search for connection by mobile phone within 1 minute, otherwise, the Bluetooth will be automatically turned off).	The icon displays at the status bar.
	Video Output	ON/OFF	Transfer the analog video in PAL through the Type-C data cable.	The icon displays at the status bar.
	Battery Type	3V/3.7V	Select 3V or 3.7V depends on the voltage of battery	The icon displays at the status bar.
	Zeroing Type	G1/G2/G3/G4	Up to four groups of calibration data can be stored	The icon displays at the status bar.
	Image Calibration	Enter image calibration interface	Shifting infrared images, ensure daylight & infrared images are in the same location	Image Calibration interface (fig. 6-3)
	E-Zoom center adjust	Enter E-zoom center adjust interface	Shifting center of E-Zoom to ensure the center of E-zoom align with day light scope's reticle	E-zoom center adjust interface (fig. 6-4)
	Bad Pixel Correction	Calibrate the bad pixels on the image	Refer to 6.8	Bad pixel calibration interface (fig.

				6-5)
	Factory Reset	Restore factory state	Y: Confirm, N: Cancel Press and hold M button to save and exit.	_____

6.6 Image Calibration

When the device is installed on the day light sight as an infrared extension component, if the reticle of white light sight is not in the center of infrared image, the image calibration function can be used to shift the infrared image to ensure the position consistency between the white light image and infrared image.

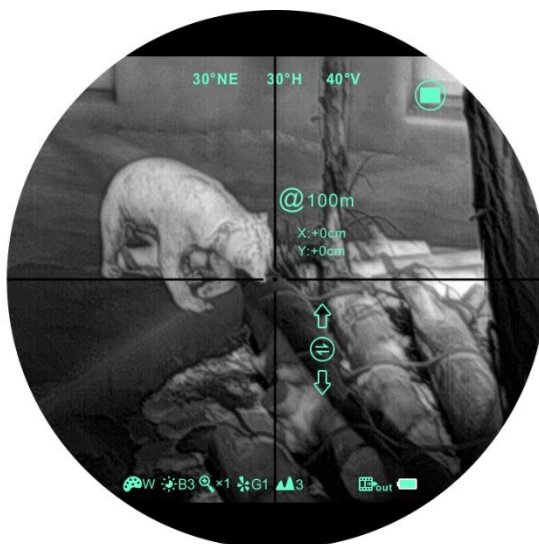

Fig. 6-3 Image calibration interface

Operation:

- Please calibrate the day light sight before mounting Clip CH50.
- Installing Clip CH50 on the day light sight and repeat the calibration steps above. Then aiming at the target at 100 meters and shoot. Measure the horizontal distance and vertical distance between the bullet hitting point and the aiming point afterwards.
- In normal display mode, press and hold down **M (5)** button to enter the image calibration interface. Pressing **P (4)** button or **C (6)** button briefly to move the position of infrared image and long press to achieve quick shift. Pressing **M (5)** button to switch the orientation of X-axis (left-right) and Y-axis (up-down) while

the moving distance is displayed synchronously above the icon. (as shown in figure 6-3)

- When the calibration is done, long press **M (5)** button to save and exit the calibration interface.

Note: Before zeroing function performs, please confirm the storage location, i.e., selection of the type of zeroing. (Refer to 6.5 for details)

6.7 E-Zoom center adjustment

- Please calibrate the image before adjusting E-zoom center.
- Hold down **M (5)** button to enter advanced menu, select E-zoom center adjust option to enter the menu.
- In the adjustment menu, move white reticle until it overlap with day light scope's reticle.
- Hold down **M (5)** button to save and exit the adjustment interface. Aim the target with E-Zoom, observe if the center of E-zoom overlap with reticle of day light scope. Repeat previous center adjustment if there is deviation.



Fig. 6-4 E-zoom center adjustment

6.8 Bad Pixel Calibration



Fig. 6-5 Bad pixel correction interface

- When enter the advanced menu, select the bad pixel calibration option and press **M (5)** button briefly to enter the bad pixel calibration interface (fig.6-5). A reticle will appear in the center of the screen.
- Then, move the reticle up-down or left-right to select the bad pixel by pressing the **P (4)** button and **C (6)** button. Press **M (5)** button briefly to switch the orientation of X-axis (left-right) and Y-axis (up-down).
- After selecting the bad pixel, press **P (4)** and **C (6)** button at the same time to calibrate the bad pixels.
- Repeat the above operations to continue selecting bad pixel, and the status bar at the bottom of the screen will display the number of calibrated bad pixels.
- When the calibration is done, press and hold **M (5)** button to exit the bad pixel correction.

6.9 Compass Calibration

- In the home screen, press and hold the **P (4)** and **C (6)** button at the same time to enter the compass calibration interface.
- An icon like a triaxial coordinate system appears on the screen (shown as fig. 6-6).
- Follow the icon prompt to rotate the riflescope along three axes at least 360 degrees each axis in the 15 seconds.

- It will automatically exit and complete compass calibration after 15s.
- During the calibration process, press **P (4)** button briefly to exit the compass calibration interface at any time.

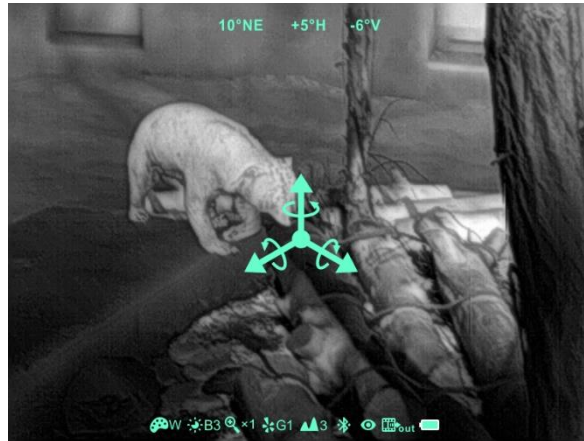

Fig. 6-6 Compass calibration interface

6.10 Stadiametric Rangefinder (Only for Monocular)

Stadiametric rangefinder is only for monocular mode that can estimate approximate distance to an object of known size.

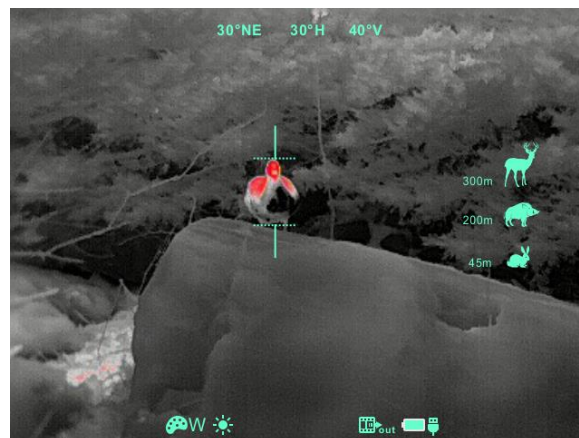

Fig. 6-7 Stadiametric rangefinder interface

- In the home screen, press and hold the **P (4)** and **C (6)** button for 3s at the same time to enter the stadiametric rangefinder interface (fig. 6-7).
- The display will show two horizontal lines for measurement, the icons and numbers of the measured distance for three objects on the right.
- There are three predefined values for objects:
 - **Deer** – height 1.7m

- **Boar** – height 0.7m
- **Hare** – height 0.3m
- Locate the target by pressing **P (4)** button or **C (6)** button until the target matches entirely between the two measurement lines. **P (4)** button is used to increase the distance and **C (6)** button to reduce the distance.
- The distance to the target is automatically recalculated while moving the measurement lines and displayed on the left of the three reference objects.
- The center and color of the measurement lines is the same as the reticle.
- Exit the rangefinder mode with a long press of the **M (5)** button.

7. Accessory Equipment: Remote control/ Mobile App



Fig. 7-1 Remote controller



Fig. 7-2 App

Clip CH50 is equipped with external devices that can be connected via bluetooth. The button layout of the bluetooth remote controller and mobile phone APP is consistent with the device, including Power button, menu button and correction button. The functions and operation methods are also corresponding with the device. (Refer to figure 7-1 and 7-2 for details)

7.1 Bluetooth Remote Controller

- Turn on the Bluetooth of the device and the icon will show at the bottom of the screen.
- Long press the Power button on the remote controller for 15 to 30s until the bluetooth icon on the screen turns to , which means connected and the remote controller is ready to use.
- After connecting to the device, if the signal is disconnected in between, the bluetooth remote control will continue to search for connection within 1 minute.
- Turn off the bluetooth on the device, and the remote controller will automatically shut down if no bluetooth signal is found within 1 minute.

7.2 Mobile App

- Turn on the bluetooth of the device and the icon will show at the bottom of the screen.
- Open the App software on the mobile phone and connect with the device within 1 minute until the bluetooth icon on the screen turns to  which means connecting successfully.
- Click the remote controller icon on the App, and operate the Clip C Series with the mobile phone.

8. Preventative Maintenance

8.1 Battery Installation

- When the icon  is appeared on the status bar, please replace with new batteries;
- It is necessary to power off before replacing the batteries.
- Turn the **battery compartment knob (10)** in a counterclockwise to open and remove it.
- Install two CR123 batteries correctly according to electrode instructions on the label inside the battery compartment as shown in fig. 8-1.
- Replace the battery cover and press heavily until heard clicking sound and make sure the cover is closed on both sides correctly.

Note:

- **This device supports disposable batteries only. That is risky when using the rechargeable batteries, due to inconsistent quality.**
- **Please do not use batteries of different types or batteries with various charge levels.**



Fig. 8-1 Schematic diagram of battery installation

8.2 Product Cleaning and Maintenance

- It is prohibited to clean the device with the cleaning tool which may corrode or scratch optical glass.

- The unit can be scrubbed with soft cloth by dipping certain amount of alcohol.
- For optical glass devices such as eyepiece lens and objective lens, dust should be blown first, and then use charcoal pen or degreasing cotton dipping non-methylated alcohol to wipe slightly.

8.3 Safety Regulation

- Please use standard batteries. Do not throw the batteries away or put them into fire after usage.
- Please use standard charger to prevent the product from damage.
- Short circuit products are prohibited.
- It is prohibited to expose the product in high temperature environment more than 60°C.
- It is prohibited to put the product into fire.

9. General Trouble Shooting

Table 9-1 General trouble shooting

Description	Probable cause	Trouble shooting
Image blurring	The focal length of the objective lens does not suit.	Adjust the focal length of objective lens until the image becomes clear.
	No image calibration for a long time.	Perform image calibration.
Blurred vision	Sight distance inadequacy.	Adjust the sight distance of eyepiece until image becomes clear.
No analog video output	Analog video not opening.	Open analog video output.
	Data cable doesn't support data transmission.	Replace data cable.
Fail to start up	Wrong battery installation or low power.	Check the battery installation and battery power.
	Insufficient external supply voltage.	Check the voltage of external power supply.
The attachment's eyepiece is stuck during installation.	Eye relief mounting limit block isn't placed parallel to the rail slot and the position is dislocation.	Loose the eyepiece, push it back to square, and then rotate the mounting.
When aiming at target, the reticle swings and cannot be aimed at the target.	The day light sight parameter is not the correction distance of 100 yards.	Replace the day light sight with a 100-yard sight.

★Please contact with us as soon as possible if there are some abnormalities. Private disassemble is strictly prohibited.

10. Appendix

10.1 User Interface Description

- Custom interface and data cable are adopted to support type-c power supply, serial port and PAL video.
- Support type-c and battery power supply, support over-voltage and under-voltage reverse connection protection.

10.2 Product Dimensions

10.2.1 Boundary Dimension

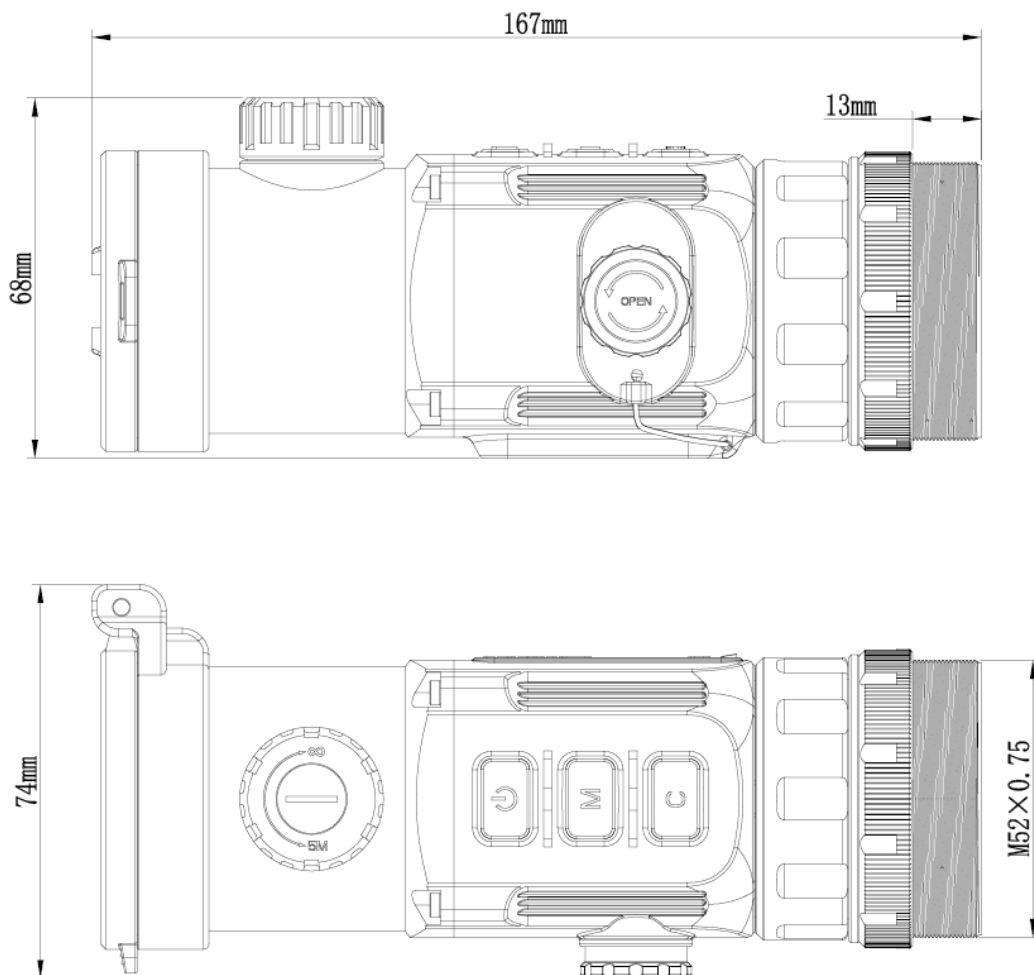

10.2.2 Bottom Mounting Hole Size

