

# FINDER

Thermal Imaging Monocular



## User Manual

FH35 V2 / FH50R V2

V1.0

# IMPORTANT SAFETY INFORMATION

## Environmental influences

- **WARNING!** Never point the lens of the device directly at intense heat sources such as the sun or laser equipment. The objective lens and eyepiece can function as a burning glass and damage the interior components. The warranty does not cover damage caused by improper operation.
- Avoid touching the metal surface (cooling fins) after exposure to sunlight or cold.

## Ergonomics notes

**Caution:** Take breaks after longer periods of use to avoid wrist pain.

## Risk of swallowing

**Caution:** Do not place this device in the hands of small children. Incorrect handling can cause small parts to come loose which may be swallowed.

## Safety instructions for use

- Handle the device with care: rough handling may damage the internal battery.

- Do not expose the device to fire or high temperatures.
- The battery capacity decreases when operated in a cold ambient temperature. This is not a fault and occurs for technical reasons.
- The recommended temperature for using this product is -20° to +50°. Otherwise, it will affect the service life of the product.
- Do not store the device for long periods at temperatures below 20°C or above 50°C. Otherwise, it will permanently reduce the capacity of the battery.
- Always store the device in a dry, well-ventilated space. For prolonged storage, remove the battery pack.
- If the device or the power unit has been damaged, send the device to our after-sales service for repair.
- Before using this product in an environment with water, ensure that the Type C cover is tightly covered.

## Safety instructions for the power supply unit

- Only use the battery charger to charge the battery pack included in the package.
- Check the power supply unit, cable and adapter for visible damage before use.

- Do not expose the battery pack to high temperature or open flame. Do not use the power unit in wet or humid environments.
- Do not charge the battery immediately after you bring it from the cold to the warm. Wait 30 to 40 minutes for it to warm up.
- Do not use the charger if it is modified or damaged. Do not make any technical modifications to the power unit.
- Do not disassemble or modify the battery pack or charger without professional instructions. Do not knock or drop the battery pack.
- Only charge the battery pack at a temperature range of 0°C ~ +45°C. Otherwise the battery life will be significantly reduced.
- When charging, please don't leave the battery unattended.
- Do not charge the battery for more than 24 hours after it is already fully charged.
- Before a long storage time, the battery pack should be partially charged, not fully charged or discharged.
- The battery pack has short circuit protection. But situations that may lead to short circuits should be avoided.
- Please keep the battery pack out of the reach of children.

### Disposal of batteries



Directive 2006/66/EC (battery directive): This product contains a battery that cannot be disposed of as unsorted municipal waste in the European Union. For battery details, refer to the documentation of the specific product. The battery is marked with this symbol, which may include Cd (indicating cadmium), Pb (indicating lead), or Hg (indicating mercury). For proper recycling, please return the battery to your supplier or send it to a designated collection point. For more information, visit [www.recyclethis.info](http://www.recyclethis.info).

### User information on the disposal of electrical and electronic devices (private households)



2012/19/EU (WEEE directive): Products marked with this symbol cannot be disposed of as unsorted municipal waste in the European Union. For proper recycling, please return this product to your local supplier when purchasing a new equivalent product, or send it to a designated collection point. For more information, visit [www.recyclethis.info](http://www.recyclethis.info).

### For business customers within the European Union

Please contact your dealer or supplier regarding the disposal of electrical

and electronic devices. He will provide you with further information.

### **Information on disposal in other countries outside of the European Union**

This symbol is only applicable in the European Union. Please contact your local authority or dealer if you wish to dispose of this product and ask for a disposal option.

### **Intended use**

The device is intended for displaying heat signatures during nature observation, remote hunting observations and for civil use. This device is not a toy for children.

Use the device only as described in this operating manual. The manufacturer and the dealer accept no liability for damages which arise due to non-intended or incorrect use.

### **Function test**

- Before use, please ensure that your device has no visible damage.
- Test to see if the device displays a clear, undisturbed image.
- Check that the settings for the device are correct. See the notes in the section Operation.

### **Installing/removing the battery**

The Finder series thermal imaging monocular is equipped with a battery pack. It cannot be removed.

### **Observation with and without glasses**

Thanks to the flexible eye-shade, the Finder series can be used with or without glasses. It offers a full field of view in both cases.

# 1 Specifications

Model	FH35R V2	FH50R V2
<b>Microbolometer</b>		
Resolution, pixels	640 × 512	
Pixel size, μm	12	
NETD, mK	≤ 20	
Frame refresh rate, Hz	50	
<b>Optical Specifications</b>		
Objective Lens, mm	35 / F0.9	50 / F1.1
Field of view, degree	12.6 × 10.1	8.8 × 7.0
Optical magnification, ×	2	3
Digital zoom, ×	1 / 1.5 / 2 / 2.5 / 3 / 3.5 / 4	
Minimum focusing distance, m	1	
Diopter, D	-5 ~ +5	
Detection range, m (Target size: 1.7 m × 0.5 m, P(n) = 99 %)	1800	2600
<b>Display</b>		
Type	OLED	
Resolution, pixels	1024 × 768	

## Operational Specifications

Battery type	Li-ion battery pack	
Max. battery life (t=25°C)*, h	5,5	
Laser rangefinder range, m	800 ± 1	
Memory capacity, GB	32	
Wi-Fi / APP	Support (InfiRay Outdoor)	
Dimension, mm	160 × 90 × 50	170 × 90 × 58
Weight, g	≤ 400	≤ 500

\* Actual operation time depends on the density of Wi-Fi use and the built-in video recorder.

- Improvements may be made to the design and software of this product to enhance its features without prior notice to the customer.
- The newest user manual can be downloaded at our official website: [www.infirayoutdoor.com](http://www.infirayoutdoor.com).

## 2 Package Contents

- Finder Series Thermal Imaging Monocular
- Portable Bag
- Type C USB cable
- HDMI cable
- Power adapter
- IBP-2 battery pack × 2
- IBC-2 battery charger
- Hand strap
- Neck strap
- Lens cloth
- Quick Start Guide

## 3 Description

The Finder series are easy to carry and can be operated with one hand. With its compact size and light weight, it can be placed in the pocket any time. The built-in laser ranging can quickly locate the target distance. The

ergonomic construction and powerful function make the Finder the best choice for outdoor exploration.

## 4 Features



- 12 $\mu$ m thermal imaging detector
- High image quality
- Integrated laser rangefinder
- Display off function
- OLED display
- Long detection distance
- Ultraclear mode for harsh weather conditions
- Cool hue and warm hue for selection
- 32GB Build-in memory
- Support photo and video recording
- Support APP connection via Wi-Fi
- Built-in digital compass and motion sensor
- Replaceable Battery Pack
- Convenient user interface

## 5 Units and Controls

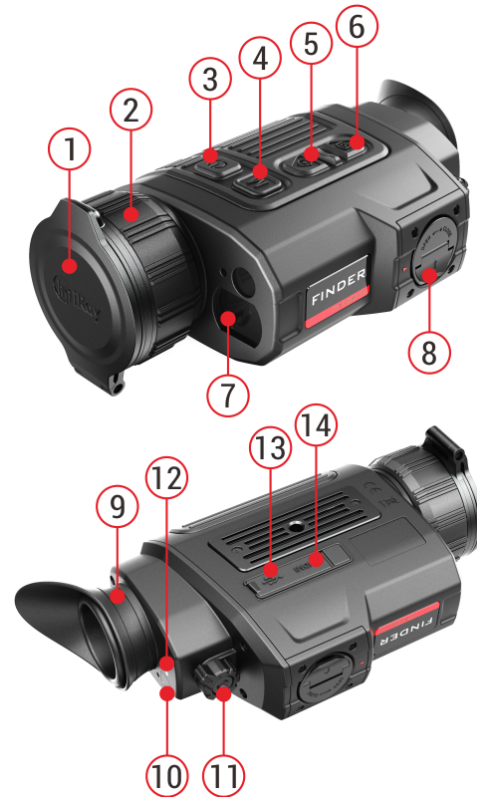
1. Lens cap
2. Lens focus ring
3. Power button
4. Menu button
5. Up / Ranging button
6. Down / Photo button
7. Laser rangefinder
8. IBP-2 battery pack
9. Eyepiece
10. Infrared sensors switch
11. Diopter adjustment
12. LED indicator
13. Type C port
14. HDMI port



## 6 Button Operations

Button	Current status	First short press	Next short press	Long press
<b>Power button</b> 	The device is off.	--	-	Power on device
	Home screen	Standby the device	Wake up the device	Power off device
	Defective pixels calibration interface	Calibrate a defective pixel	Undo the pixel calibration	Undo all calibrations of this operation
	Shortcut menu / Main menu	Return to the home screen	Standby the device	--
	Laser rangefinder	Turn off the laser rangefinder function	Standby the device	Power off device
<b>Menu button</b> <b>M</b>	Home screen	Open shortcut menu 1	Open shortcut menu 2	Open the main menu
	Shortcut menu 1	Open shortcut menu 2	Exit the shortcut menu	--
	Shortcut menu 2	Exit the shortcut menu	Open shortcut menu 1	--
	Main menu	Switch the parameters / Enter the submenu		Exit menu option / main menu
	Defective pixels calibration interface	Switch movement direction of the cursor		Save and exit calibration
<b>Up / Ranging button</b> 	Home screen	Turn on the laser rangefinder function		--
	Single ranging mode	Make a single ranging		Switch the ranging mode
	Shortcut menu 1	Adjust E-zoom		--
	Shortcut menu 2	Adjust display brightness		--
	Main menu	Toggle menu options up		--
	Defective pixels calibration interface	Move up / right slowly		Move up / right quickly



<b>Down / Photo button</b> 	Home screen	Take a photo	Start video recording
	Videoaufnahme	Take a photo	Stop and save video recording
	Shortcut menu 1	Image mode adjustment	--
	Shortcut menu 2	Adjust image contrast	--
	Main menu	Toggle menu options down	--
	Defective pixels calibration interface	Move down / left slowly	Move down / left quickly
<b>Up + Down</b>	Home screen	Shutter correction	Background correction

## 7 Battery Pack

Finder series thermal imaging monocular is supplied with a quickly removable 18650 Li-ion battery pack, which enabled the device to be used for up to 6h. The battery should be fully charged before first use.

### Battery Pack Installation

- Turn up the puller **(15)** on the battery pack **(8)**, and align the orange line **(D)** on the battery pack **(8)** with the triangle symbol **(C)** on the battery slot **(16)** and push the battery pack **(8)** into the battery slot **(16)**.
- When the battery pack is completely inserted into the battery slot, turn

the puller **(15)** clockwise to lock the battery pack.

- Close the puller **(15)**, and the battery pack is completely installed.
- Finder can only be powered by this battery pack. If other battery packs are used, it may cause irreparable loss, damage to the device, and can even possibly cause fire.

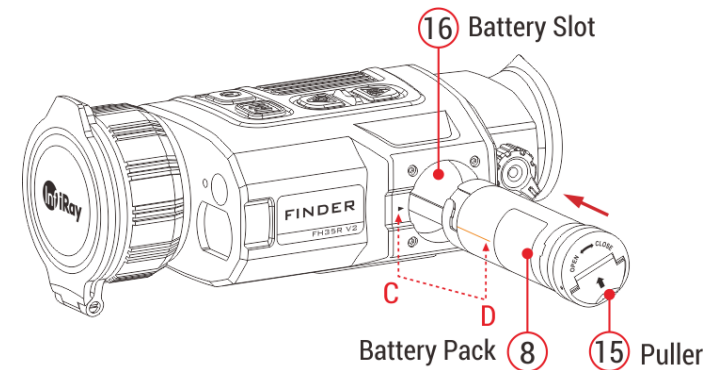

## Method 1: Charging with Type-C Port

- When the battery pack is installed into battery slot of the Finder series, connect the Type C end of the data cable (18) to the Type C port (13) of the product.
- Connect the other end of the data cable (18) to the power adapter (19) that comes with the product, or connect to another USB power socket with a rated output voltage not exceeding 5V.
- Plug the adapter (19) into a 100-240V power socket (20) for charging.
- When charging, the LED indicator (12) will change to red. Unplug the cable when the LED indicator changes to green.

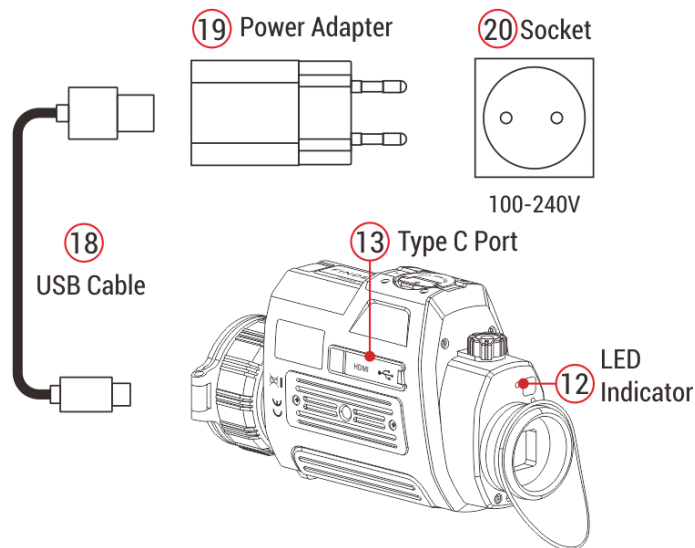

## LED indicator displaying the current status of the device

LED Color	LED Status	Operating Mode
●	Normal	Full charged
	Flashing	Standby
●	Normal	Charging
	Flashing	Less than 10% battery level

## Method 2: Charging with Battery Charger

- Align the positioning block (A) of the battery pack (8) with the groove (B) of the battery charger (15), and insert the battery pack (8) into the battery charger (15).
- Connect the plug of the USB Type-C cable (18) to the USB connector of the power adapter (19). Plug the power adapter (19) into a socket 100-240V (20) (110V for US).
- Connect the other end of the USB cable (18) to the Type-C port (16) of the battery charger (15).
- After finishing the above steps, the LED indicator (17) on the battery charger (15) will display the battery charge state.
- After the battery is fully charged, remove the battery pack from the battery charger.

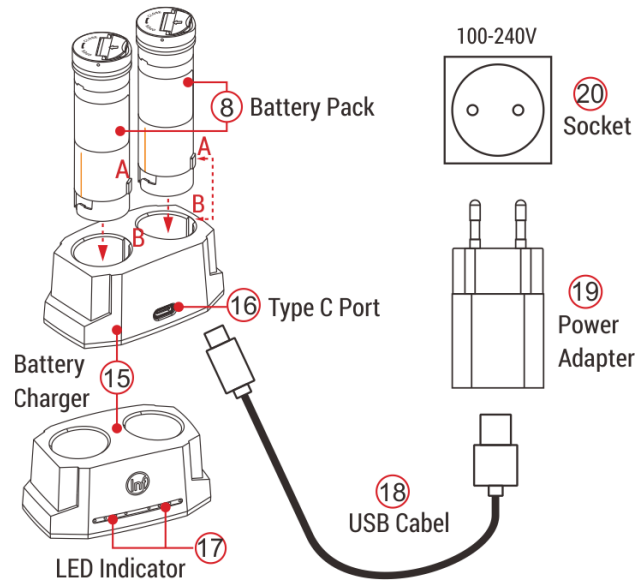

**Battery charge status (see table)**

LED Indicator	Battery charge status
	Battery level is from 1 % to 25 %.
	Battery level is from 25 % to 50 %.
	Battery level is from 50 % to 75 %.
	Battery level is from 75 % to 99 %.
	Battery is full charged.

**Note:** Two batteries can be charged at the same time: the second slot is designed for it.

## 8 External Power Supply

Finder series supports external power supply, such as the portable power source (5V).

- Connect the external power supply to the Type-C port (13) of the device.
- The device will automatically switch to the external power supply and charge the battery pack (8) at the same time.
- At this time, the battery icon on the display will become to the charging icon and the power indicator will turn red, and then turn green after the battery is fully charged.
- If an external power supply is connected, but no battery pack is installed, the battery icon will become a USB icon and the power indicator will turn green.
- When the external power supply is disconnected, Finder series will automatically switch to the battery pack power supply and will not be shut down.

# 9 Icon Descriptions

	White Hot
	Black Hot
	Red Hot
	Target Highlight
	Ironbow
	Rainbow
$\times 1/\times 1,5/\times 2/\times 2,5/\times 3/\times 3,5/\times 4$	Digital Zoom
	Display brightness
	Image sharpness
	Automatic calibration
	Manual calibration
	Ultraclear mode
	Wi-Fi
	Video out
	PIP
	Digital compass

	Motion sensor
	Auto display off
	Micphone
	Switch unit
	More
	Calibration mode
	Image hue
	Defective pixel calibration
	Compass calibration
	Time and date
	System information
	Factory reset
	Return to the main menu
	Single ranging
	Continuous ranging
	Battery indication
	Battery charging

## 10 Operation

### Power on and image adjustment

- Remove the **lens cap (1)**. Press and hold the **Power button (3)** for 2s to power on the device. Then, the home screen appears after 10s.
- Rotate the **eyepiece diopter adjustment (11)** to adjust the resolution of the icons on the display. After the adjustment is completed, for the same user, when using it again there is no need to adjust the diopter again.
- Rotate the **lens focus knob (2)** to focus on the object observed.
- Set the digital zoom, image mode, screen brightness and image sharpness with a short press of the **Menu button (4)** (Refer to the **Shortcut Menu section** in this manual for details).

### Shut Down

- After using the device, press and hold the **Power button (3)** for 3 seconds. The shutdown countdown screen will appear.
- When the countdown from 3 to 0 is completed as indicated by the



countdown icon, the device is powered off. Then release the button. The display is off, the indicator is off, and the device is shut down.

### Standby

- The standby mode can let the device into a sleep state (turn off the display screen, the main chip is standby).
- In the home screen, press the **Power button (3)** briefly to standby the device.
- Press the **Power button (3)** again to wake up the device.

### Home Screen

When the device booted up, the home screen shows upon. There is some general information shown on the interface.



Detail as follows:

- **Upper left corner** - Color palette, magnification, calibration mode, Wi-Fi (on), Automatic screen off (on), Ultraclear mode (on), Microphone (on)
- **Upper right corner** - Battery level



- **Lower left corner** - Time and date
- **Lower right corner** - Video output icon (when it is on).

The color of the battery icon represents the current battery level. When the battery icon is shown in red, it indicates that the battery is low. Please charge it in time.

Icon	Color	Battery level
	Blue	30 %-100 %
	Yellow	20 %-30 %
	Red	Less than 10 %
	--	Charging

## 11 Calibrate the Sensor

When the image is degraded or uneven, it can be improved by calibration. Calibration enables the detector temperature background to be equalized and defects in the image to be eliminated.

There are two calibration modes: manual calibration (M) and automatic calibration (A).

Select the required mode in the **Main Menu**.

- **A mode (automatic)**. The device is calibrated autonomously by the

software algorithm. The lens cap need not be secured (the sensor is closed by an internal shutter).

- **M mode (manual)**. The device needs to be calibrated manually.
  - Short press the **Up (5) + Down (6)** buttons for shutter calibration, and long press for background calibration.
  - The lens cap should be closed for background calibration.

**Note:** Manual shutter calibration and manual background calibration are still possible even in mode A.

## 12 Photography and Video Recording

Finder V2 Series thermal imaging monocular is equipped with a function for video recording and photographing an observed image onto the built-in memory card.

The files of images and videos will be named after the time, so it is recommended to reset the system time in the **Main Menu** or to synchronize the system time and date in the Settings of the APP before using the camera and video function. For specific operations, you can download the operating instructions of the APP from the company's website.

## Photography

- Take a photograph with a short press of the **Down/Photo (6) button** in the home screen. The image freezes for 0.5 seconds with a photo icon (  ) displayed on the upper-right corner of the display.
- The picture file is saved to the build-in memory card.

## Video Recording

- In the home screen, press and hold the **Down/Photo (6) button** to start video recording.
- A tooltip  00:01 showing the recording time (showing in MM: SS (minutes: seconds) format) will appear in the upper right corner of the display.
- The red dot in the tooltip flashes during recording.
- During recording, short press the **Down/Photo (6) button** to take a photo also.
- Stop the video recording by pressing and holding down the **Down/Photo (6) button**.
- Video and picture files are stored in the built-in memory card after video recording has been turned off.

### Note

- You can enter and work on the menu during video recording.
- The recording time is accumulated in minutes until the recording stops, that is, the time shows 60:00 after 59:59.
- The maximum duration of a video recording file is 10 minutes. When it's more than 10 minutes, the video will be recorded onto a new file.
- The number of files is limited by the capacity of the device's built-in memory. Regularly monitor the amount of free memory in the built-in memory card, transferring footage and photos to other media to free up space on the memory card.

## Memory Access





When the device is turned on and connected to a computer, it is recognized by the computer as a flash memory card, which is used to access the device's memory and make copies of pictures and videos.

- Turn on the device and connect it to the computer through the USB cable.
- Double-click "my computer" on the desktop - double-click to open the device named "InfiRay" - then click and open the device named "Internal Storage" to access memory.

- There are different folders named by time in memory.
- Recorded videos and photographs are saved in these folders in the format: IMG\_HHMMSS.jpg (for photos) and VID\_HHMMSS.mp4 (for video). HHMMSS- hour/minute/ second.

## 13 Laser Rangefinder

Finder series is built-in laser rangefinder module.

- Short press the **Up/Ranging (5) button** to switch on the laser rangefinder function in the home screen.
- A blue cursor  appears automatically on the screen, and the tooltip  at the bottom of the screen displays the current ranging mode and the distance of the target indicated by the cursor.
- There are two kinds of ranging modes: single ranging  and continuous ranging  . Press and hold the **Up/Ranging (5) button** to switch between the two modes.
- In the single ranging mode,



short press the **Up/Ranging (5)**

**button** is required for ranging.

- In the continuous ranging mode, the distance of the target indicated by the cursor will be refreshed automatically every 1 second, without any keystroke operation.
- The measurement range and accuracy is  $800m \pm 1m$ , and it will be affected by fog and heavy rain and other weather.
- After the measurement is completed, short press the **Power button (3)** to exit the laser rangefinder function.



## 14 Shortcut Menu Function

The basic settings (such as the smooth digital zoom function, the image mode, the display brightness and the image sharpness) are adjusted in the Shortcut Menu.

- In the home screen, by pressing the **Menu (4) button** to enter shortcut menu 1-shortcut menu 2-exit the menu accordingly.



- After entering the menu, press the **Up (5) button** to set the parameters at the top of the screen and press the **Down (6) button** to set the parameters at the bottom of the screen.

- **Smooth Digital Zoom** - by pressing the **Up (5) button** to change the digital zoom value from 1.0 to 4.0 in the shortcut menu 1.



- **Image Mode** - by pressing the **Down (6) button** to change the image mode in the shortcut menu 1. The icons from left to right are white hot, black hot, red hot, hot target highlight, ironbow and rainbow.

- **Display Brightness** - by pressing the **Up (5) button** to change the display brightness level from 1 to 5 in the shortcut menu 2.



- **Image Contrast** - by pressing the **Down (6) button** to change the image contrast level from 1 to 5 in the shortcut menu 2.

- An automatic exit from the menu occurs after 10 seconds of inactivity. Also, it will return to the home screen quickly with a short press the **Power (3) button**.

## 15 Main Menu Function

- Enter the menu with a long press of the **Menu (4) button** in the home screen.
- Press the **Up (5) / Down (6) button** to move through the menu functions, and the background of the option will become blue simultaneously.
- Press the **Menu (4) button** to set the parameters of the current option, or open the menu item.
- On the “More “ option, short press the **Menu (4) button** to enter the sub menu for more settings.
- The button operation of the sub menu is the same as that of the Main Menu.
- Press and hold down the **Menu (4) button** to exit the menu.
- An automatic exit from the menu occurs after 10 seconds of inactivity. Also, it will return to the home screen quickly with a short press the

### Power (3) button.



### 👁️ Ultraclear - Selection of the Ultraclear mode

- Press and hold the **Menu button (4)** to enter the menu.
- Select the 'Ultraclear' option with **Up (5) / Down (6) button**.
- Short press **Menu button (4)** to turn the Ultraclear on/off.
- When the Ultraclear mode is on, the image contrast is enhanced, which is suitable for rainy, foggy and other harsh weather conditions.

### 📶 Wi-Fi - Selection of the Wi-Fi function

- Press and hold the **Menu button (4)** to enter the menu.
- Select the 'Wi-Fi' option with **Up (5) / Down (6) button**.
- Short press the **Menu button (4)** to turn the Wi-Fi on/off.
- The Wi-Fi icon is displayed in the upper-left status bar when it is on.

### 📺 Video Out - Selection of the video out function

- Press and hold the **Menu button (4)** to enter the menu.
- Select the 'Video out' option with **Up (5) / Down (6) button**.
- Short press the **Menu button (4)** to turn the video out on/off.
- The Video out icon is displayed in the lower-right corner when it is on.

### 🖼️ PIP Mode - Selection of the Picture in Picture Mode

- Press and hold the **Menu button (4)** to enter the menu.
- Select the 'PIP Mode' option with **Up (5) / Down (6) button**.
- Short press the **Menu button (4)** to turn the PIP on/off.
- A 2x magnified image in a separate 'window' appears at the top of the display simultaneously with the main image

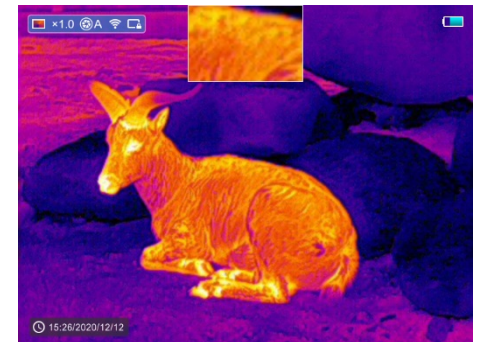

### 📍 Digital Compass - Selection of the Digital Compass

- Press and hold the **Menu button (4)** to enter the menu.
- Select the 'Digital Compass' option with **Up (5) / Down (6)**



with **Up (5) / Down (6) button**.

- Short press the Menu button (4) to enter the sub menu for more settings.



**Calibration Mode** - Selection of calibration mode

There are two calibration modes: automatic(A) and manual(M).

- Press and hold the **Menu button (4)** to enter the menu.
- Select the 'Calibration Mode' option with **Up (5) / Down (6) button**.
- A short press of the **Menu button (4)** to select A or M.

**Automatic(A)**  **A**

Calibration requirements in the automatic mode are determined by the software algorithm, with the calibration process being started automatically.

**Manual(M)**  **M**

The user independently sets the calibration requirements according to the image being observed.



**Image Hue** - Selection of image hue

There are two hues for selection: cool hue© and warm hue(W).

- Press and hold the **Menu button (4)** to enter the menu.

- Select the 'Image Hue' option with **Up (5) / Down (6) button**.
- Short press the **Menu button (4)** to select C or W.
- The switch between the warm and cool hues is not appears at the top of the display simultaneously with the main image.

**Cold hue mode**

Image will be more contrast, more hierarchy, and more obvious targets.

**Warm hue mode (W)**

Image will be softer, it can be reducing the visual fatigue of the observer, and long time observation is not dazzling.



**Defective Pixels Calibration**

When using the device, defective (broken) pixels may appear on the sensor: i.e., bright or dark points of constant brightness that are visible on the image. The Finder Series supports automatic defective pixels calibration.

- In the More submenu interface, select the 'Defective Pixels Calibration' option with **Up (5) / Down (6)**

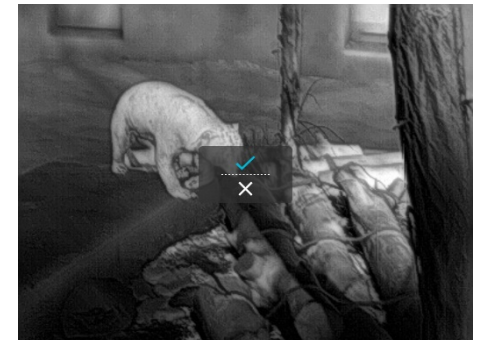

**button.**

- Enter the Defective Pixels Calibration interface with a short press of the Menu button (4).
- Select the option ' ✓ ' or ' ✕ ' with the **Up (5) / Down (6) button.**
- Short press the **Menu button (4)** to confirm selection.
- When ' ✓ ' is selected, it will calibrate all defective pixels automatically. When ' ✕ ' is selected, it will cancel and return to the upper interface.



**Compass Calibration** - Calibrate the digital compass

- Open the sub menu by pressing the **Menu button (4)**.
- Select the 'Compass Calibration' option with the **Up (5) / Down (6) button.**



- Enter the compass calibration interface with a short press of the **Menu button (4)**.
- An icon like a triaxial coordinate system appears on the screen.

- Rotate the device at least one 360° in three axial directions in 15 seconds according to the direction shown as the icon to complete the compass calibration.
- Press the **Power button (3)** briefly to terminate and exit the calibration without saving within 30 seconds.



**Time Settings** - Reset the system date and time

- Open the sub menu by pressing the **Menu button (4)**.
- Select the 'Time Settings' option with the **Up (5) / Down (6) button.**
- Short press of the **Menu button (4)** to enter the time settings interface, that is displayed as Year. Month. Day | Hour: Minute format.
- Short press the **Menu button (4)** to switch between digits.
- Select the correct value with a short press of the **Up (5) / Down (6) button.**
- Long press the **Menu button (4)** to exit to the upper interface.



**System Information** - View the information of this device

- Open the submenu by pressing the **Menu button (4)**.

- Select the 'System Information' option with the **Up (5) / Down (6) button**.

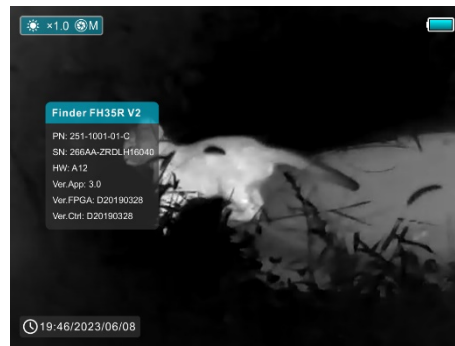

- Open the system information box with a short press of the **Menu button (4)**.
- Long press the **Menu button (4)** to exit to the upper interface..

### **Factory Reset** - Restore Factory Settings

- Open the sub menu by pressing the **Menu button (4)**.
- Select the 'Factory Reset' option with the **Up (5) / Down (6) button**.
- Short press of the **Menu button (4)** to enter the 'Factory Reset' submenu.
- Select the option ' ✓ ' to reset to factory settings or ' ✕ ' to cancel with the Up (5) / Down (6) button.



- Confirm your selection with a short press of **Menu button (4)**.

The following settings will be restored to their factory state before being set by the user:

- |  |                                     |
|--|-------------------------------------|
| <b>Image mode</b> - white hot                                | <b>Digital zoom</b> - ×1            |
| <b>Image hue</b> – warm                                      | <b>Display brightness</b> - level 3 |
| <b>Image sharpness</b> - level 1                             | <b>Calibration mode</b> - automatic |
| <b>System time</b> - 00:00 2020/01/01                        |                                     |
| <b>Video out / PIP / MIC / Compass / Motion sensor</b> - off |                                     |
| <b>Automatic Display off / Ultraclear mode / Wi-Fi</b> - off |                                     |

**Note:** When factory Settings are restored, the Wi-Fi name and password are also restored to factory default Settings.

### **Return To The Main Menu**

- Open the sub menu by pressing the **Menu button (4)**.
- Select the 'Return to Main Menu' option with the **Up (5) / Down (6) button**.
- Return to the main menu interface with a short press of the **Menu button (4)**.

## 16 Wi-Fi Function

The device is equipped with wireless communication with external devices (computer, smartphone) via Wi-Fi.

- Press and hold the **Menu button (4)** to enter the menu.
- Select the 'Wi-Fi' option with the **Up (5) / Down (6) button**.
- Short press the **Menu button (4)** to turn the Wi-Fi on.
- The device is recognized by an external device under the label 'Finder\_XXXXX-XXXXXX', XXXXX-XXXXXX is the SN code of the device.
- Enter the password on an external device, and establish a connection. The initial password is 12345678.
- And then, the device can be controlled through the APP.

### Setting Wi-Fi Name and Password

The name and password of the Wi-Fi in Finder series can reset on the **InfiRay Outdoor App**.

- After the device is connected to the mobile device, locate and click the **'Settings'** icon  on the **InfiRay**

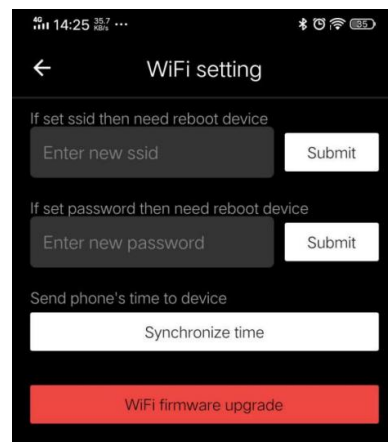

**Outdoor** image screen to enter the **Settings** interface.

- In the text box, enter and submit the new Wi-Fi name (SSID) and password.
- It needs to reboot the device to take the new name and password effect.

**Note:** If the device is reset to the factory settings, the name and password of the Wi-Fi will also be restored to the default settings.

## 17 InfiRay Outdoor and Update

In order to continuously improve the product performance and provide better user experience, the software program, as well as parameters and operating instruction of the device will be constantly updated. Users can go to the official website ([www.infirayoutdoor.com](http://www.infirayoutdoor.com)) to download and update.

About InfiRay Outdoor

- The InfiRay Outdoor APP can be downloaded on the official website or App store or scanning the QR code.
- Open InfiRay Outdoor APP after



installation.

- If your device is already connected with a mobile device, please switch on the mobile data in mobile device. After connection, the update detection is performed automatically with a prompt in the application. Click 'Now' to download the updates or click 'Later' to update later.
- InfiRay Outdoor will automatically store the last connected device. So, if your device has not connected with your mobile device, but linked to InfiRay Outdoor before, the update prompt will appear if there is an update when turning on InfiRay Outdoor. You can download the update first via mobile Wi-Fi and then connect your device with mobile device to finish the update.
- After finishing the update, the device will root.
- Instructions for using InfiRay Outdoor can also be downloaded from the official website.

## 18 Technical Inspection

A technical inspection of the device is recommended before use.

- Check the external appearance of the device (there should be no cracks in the casing).

- Check the condition of the lens and eyepiece (there should be no cracks, greasy spots, dirt or other deposits)
- Check the condition of the rechargeable battery (this should be charged) and the electrical contacts (there should be no presence of salts or oxidation).

## 19 Maintenance

The maintenance should be carried out at least twice a year and includes the following steps:

- Wipe the surface of metal and plastic parts to clear off dust and dirt with a cotton cloth. Silicone grease may be used for cleaning process.
- Clean the electric contacts and battery slots on the device using a non-greasy organic solvent.
- Check the glass surface of the eyepiece and lens. If necessary, clear off the dust and sand on the lens (it is perfect to use a non-contact method). Use a specialized wiping tool and solvent to clean the optical surfaces.



## 20 Troubleshooting

This table lists all the problems that may arise when operating the device.

Carry out the recommended checks and repairs in the order shown in the

table. If a defect should occur that is not listed in the table, or if it is impossible to repair the defect yourself, the device should be returned for repair.

Malfunction	Possible reason	Solution
Thermal imager does not power up.	Battery completely discharged	Charge the battery
Does not operate from external power source.	USB cable damaged	Replace USB cable
	External power source discharged	Charge external power source (if necessary).
Image is unclear, with vertical lines and uneven background.	Calibration required	Perform image calibration according to Section 'Calibration' of the Manual.
The image is too dark.	Low brightness level set.	Adjust display brightness.
Colored lines appeared on display or the image has disappeared.	The device was exposed to static electricity during operation.	After exposure to static electricity, the device may either reboot automatically or require turning off and on again.
Poor image quality/ reduced detection distance	These problems may occur during observation in difficult weather conditions(snow, rain, fog, etc. ).	
Smartphone or tablet cannot be connected to the device	The device password has been changed.	Delete the network and reconnect using the device password.
	The device is in an area with a large number of Wi-Fi	To ensure stable Wi-Fi operation, relocate the device to an area with fewer Wi-Fi networks, or

	networks that may cause interference.	into an area with none.
Wi-Fi signal non existent or interrupted.	The device is outside the area of Wi-Fi coverage. There are obstacles between the device and the receiver (e.g. concrete walls.)	Relocate the device into direct line of sight of the Wi-Fi signal.
When used in low-temperature conditions, the image quality of the surroundings is worse than in positive temperature conditions.	<p>In positive temperature conditions, objects being observed (surroundings and background) heat up differently because of thermal conductivity, thereby generating a high-temperature contrast. Accordingly, the image quality produced by the device will be higher.</p> <p>In low-temperature conditions, objects being observed (background) do, as a rule, cool down to roughly the same temperature because of which temperature contrast is substantially reduced and the image quality (detail) is poorer. This is a feature of thermal imaging devices.</p>	

## 21 Legal and Regulatory Information

Wireless transmitter module frequency range:

**WLAN: 2.412-2.472GHz**

Wireless transmitter module power < 20dBm

 We, IRay Technology Co., Ltd., hereby declares that the radio equipment Finder series is in compliance with the Directives

2014/53/EU and 2011/65/EU.

### FCC Statement

**FCC ID: 2AYGT-26-00**

### Labeling requirements

This device complies with part 15 of the FCC Rules. Operation is subject to the following two conditions: (1) This device may not cause harmful

interference, and (2) this device must accept any interference received, including interference that may cause undesired operation.

### Information to the user

Any Changes or modifications not expressly approved by the party responsible for compliance could void the user's authority to operate the equipment.

### EMC Class A

**Note:** This equipment has been tested and found to comply with the limits for a Class A digital device, pursuant to part 15 of the FCC Rules. These limits are designed to provide reasonable protection against harmful interference when the equipment is operated in a commercial environment. This equipment generates, uses, and can radiate radio frequency energy and, if not installed and used in accordance with the instruction manual, may cause harmful interference to radio communications. Operation of this equipment in a residential area is likely to cause harmful interference in which case the user will be required to correct the interference at his own expense.

To comply with RF exposure requirements, a minimum separation distance of 0.00 cm must be maintained between the user's body and the handset, including the antenna.

## Laser Statement

### Caution statement

Caution: Use of controls or adjustments or performance of procedures other than those specified herein may result in hazardous radiation exposure.

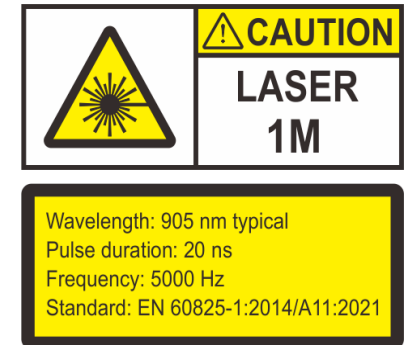

### Information for the user

Telescopes and binoculars may pose an eye hazard and thus the user should not direct the beam into an area where such instruments are likely to be used.

### Certification label

And it is a Class IM laser product that complies with 21 CFR 1040.10 and 1040.11 except for conformance with IEC 60825-1 Ed. 3., as described in Laser Notice No. 56, dated May 8, 2019.



IRay Technology Co., Ltd.

 **Tel :** 0086-400-999-3800

 **E-mail :** [infirayoutdoor@infiray.com](mailto:infirayoutdoor@infiray.com)

 **Website :** [www.infirayoutdoor.com](http://www.infirayoutdoor.com)

 **Address :** 11th Guiyang Street, YEDA, Yantai, P.R. China